

## Mechanical Properties of Normal and High-strength Concrete with Steel Fibers

TAMIM A. SAMMAN, FAISAL F. WAFÄ and TALAL A. RADAIN  
*Civil Eng. Dept., Faculty of Engineering,  
King Abdulaziz University, Saudi Arabia*

**ABSTRACT.** High-strength concrete is a brittle material, and the higher the strength of concrete the lower its ductility. This inverse relation between strength and ductility is a serious drawback for the use of higher-strength concrete, and a compromise between these two characteristics of concrete can be obtained by adding discontinuous fibers. Addition of fibers to concrete makes it more homogeneous and isotropic and transforms it from a brittle to a more ductile material. The objective of this study is to investigate experimentally the mechanical properties of normal and high-strength steel fiber reinforced concrete. A total of 288 specimens with concrete compressive strength ranging from 24 to 81 MPa (3,500 to 11,700 psi) were tested in this investigation to evaluate the effect of steel fibers on the stress-strain behavior, compressive strength, modulus of rupture, splitting tensile strength, modulus of elasticity and Poisson's ratio of both normal and high-strength concrete.

### 1. Introduction

The term high-strength concrete (HSC) is generally used for concrete with compressive strength higher than 42 MPa (6,000 psi). The use of high-strength concrete in the construction industry has steadily increased over the past years and leads to the design of smaller sections. This in turn reduces the dead weight allowing the design of longer spans and more usable area of buildings. Reduction in mass is also important for economical design of earthquake resistant structures<sup>[1-3]</sup>. Such advantages often outweigh the higher production cost of high-strength concrete associated with careful selection of ingredients, mix proportioning, curing and quality control.

High-strength concrete is a brittle material, and as the concrete strength increases the post-peak portion of the stress-strain diagram descends steeply or al-

most vanishes<sup>[1,3-7]</sup>. The increase in concrete strength reduces its ductility. This inverse relation between strength and ductility is a serious drawback for the use of high-strength concrete, and a compromise between these two characteristics of concrete can be obtained by adding discontinuous fibers. The concept of using fibers to improve the characteristics of construction materials is very old<sup>[8-13]</sup>. Addition of fibers to concrete makes it more homogeneous and isotropic and transforms it from a brittle to a more ductile material. When concrete cracks, the randomly oriented fibers arrest the cracks and limit its propagation, thus improving strength and ductility.

The main objective of this investigation is to study the mechanical properties of normal and high-strength fiber reinforced concrete materials. A total of 288 specimens were prepared and tested to study the effect of fiber content on the compressive strength along with compressive stress-strain relationship, splitting tensile strength, modulus of rupture and load-deflection diagrams.

## 2. Experimental Program

In this paper, various properties of fiber reinforced concrete (FRC) are reviewed. The effects of the concrete compressive strength, the fiber content and the specimen size are also examined. All tests were performed following ASTM standards and ACI 544.2R recommendations<sup>[14]</sup>.

Table 1 presents the concrete mix proportions used in the testing program. General purpose Type I ordinary portland cement and natural desert sand with high fineness modulus of 3.1, and a specific gravity of 2.69 were used. Coarse aggregate (crushed basalt) with a maximum size of 9.5 mm (3/8 in.), a crushing strength of 7.7%, a specific gravity of 2.84 and an impact value of 3.8% was used. Light gray densified-microsilica (10% of cement weight) with a specific gravity of 2.2, a bulk density of 6.0 kN/m<sup>3</sup> (37.4 lb/ft<sup>3</sup>) and a specific surface of 23 m<sup>2</sup>/g was used in the highest strength mix.

Hooked-ends mild carbon steel fibers used. The average fiber length is 60 mm (2.36 in.), the nominal diameter is 0.8 mm (0.03 in.), the aspect ratio is 75, and the yield strength is 260 MPa (37,681 psi). The fibers come in water soluble glued bundles to ensure their good dispersion in the concrete during mixing. A group consists of about 30 steel-fibers of average width of 24 mm (0.94 in.) as shown in Fig. 1. The collated fibers create an artificial aspect ratio of approximately 15. The fiber content dosage ( $V_f$ ) ranged from zero to 1.5% by volume of concrete.

Due to the relatively low water content and high cement and micro-silico contents, and also due to the absence of a larger coarse aggregate content, the efficient mixing of high-strength concrete is more difficult than conventional

TABLE 1. Summary of test results.

Group no.	Mix no.	Mixture* proportion C:F.A.:C.A.	W/C	Adm (%)	Silica fume (%)	Fiber (%)	Slump (mm)	f <sub>c</sub> (MPa)			f <sub>c</sub> (MPa)		f <sub>sp</sub> (MPa)	Density (Kg/m <sup>3</sup> )		E (GPa)	μ	Ductility (kN-mm)
								(150) Cyl.	(100) Cyl.	(150) Cube	(150) Prism	(100) Prism		(150) Cyl.	(100) Cyl.			
A	1	1:1.63:2.11	0.60	2	-	0.0	155	23.86	24.95	(150) Cube	3.73	3.87	2425	2438	17.29	0.12	11	
	2	1:2.25:2.25	0.45	2	-	0.0	60	47.40	48.01	50.42	4.62	4.80	2465	2465	27.48	0.19	15	
	3	1:1:2	0.30	4	-	0.0	100	54.78	61.06	64.48	6.32	6.72	2505	2507	28.31	0.19	35	
	4	1:2:2	0.24	7	10	0.0	50	72.10	71.79	87.30	9.14	8.10	2508	2540	33.31	0.19	25	
B	1	1:1.63:2.11	0.60	2	-	0.5	-	31.17	32.00	35.15	4.26	4.25	2440	2453	19.98	0.15	30	
	2	1:2.25:2.25	0.45	2	-	0.5	-	51.73	51.98	52.00	5.93	5.45	2501	2491	28.81	0.20	30	
	3	1:1:2	0.30	4	-	0.5	-	57.24	62.30	67.08	6.97	7.44	2590	2588	29.23	0.20	60	
	4	1:1:2	0.24	7	10	0.5	-	78.61	79.43	95.07	9.44	9.51	2562	2620	34.00	0.20	75	
C	1	1:1.63:2.11	0.60	2	-	1.0	-	33.82	32.76	35.82	6.88	6.99	2443	2470	20.74	0.16	83	
	2	1:2.25:2.25	0.45	2	-	1.0	-	52.00	53.20	54.15	7.59	7.49	2505	2510	29.98	0.21	120	
	3	1:1:2	0.30	4	-	1.0	-	62.86	60.32	68.62	10.27	10.33	2595	2616	30.72	0.21	65	
	4	1:1:2	0.24	7	10	1.0	-	80.12	80.68	81.51	9.49	14.62	2629	2627	34.88	0.21	110	
D	1	1:1.63:2.11	0.60	2	-	1.5	-	35.82	35.32	36.39	7.82	7.83	2486	2489	20.86	0.19	87	
	2	1:2.25:2.25	0.45	2	-	1.5	-	53.10	54.20	55.95	7.88	8.91	2513	2514	30.54	0.22	230	
	3	1:1:2	0.30	4	-	1.5	-	64.18	64.52	70.91	13.80	12.07	2606	2618	31.08	0.22	100	
	4	1:1:2	0.24	7	10	1.5	-	81.10	81.82	82.00	13.84	17.10	2643	2669	35.04	0.22	430	

\*C: Cement, F.A.: Fine Aggregate, C.A.: Coarse Aggregate.

concrete. For these reasons, a superplasticizer was used and the mixing time was increased to produce uniform concrete without any segregation. The hooked steel fibers performed well during mixing and no balling occurred. For mixes with 1.5% fiber content, extra time was required for mixing and finishing the specimen surfaces. All specimens were covered with wet burlap for 24 hours, then demolded and cured under water (25°C) until one day before testing. All specimens were tested after 28 days from casting.

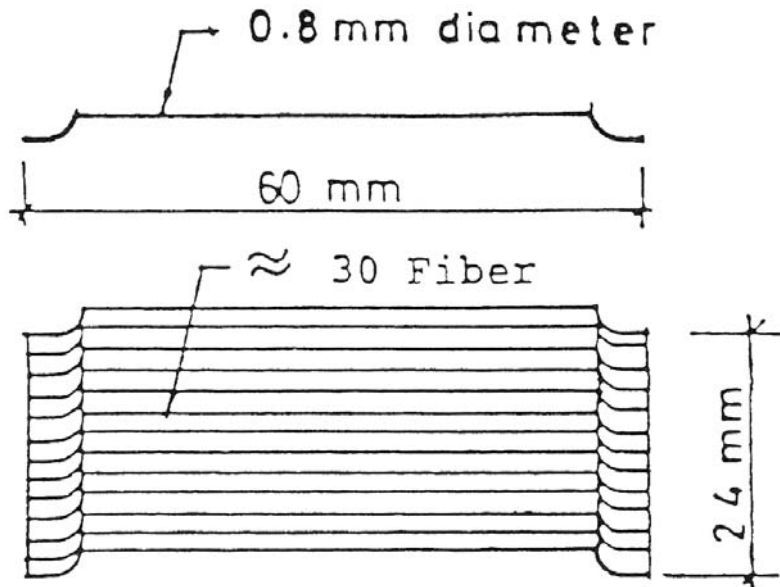

FIG. 1. Details of steel fiber.

### 3. Test Results

#### 3.1. Compressive Strength

The compressive strength tests (ASTM C 31, C 39, and C 192) were carried out using  $150 \times 300$  mm and  $100 \times 200$  mm cylinders and 150 mm cubes loaded uniaxially. Test results show that the addition of fibers improved the compressive strength values. Fig. 2 shows the effect of fiber content on the stress-strain curves of specimens tested in compression. The figure shows that the ascending portion of the curve for the specimens with the higher concrete strength is steeper than that of the lower strength concrete and is almost a straight line. The descending part of the plain concrete with no fiber almost vanished and specimens failed violently. The fiber addition influence both the ascending and descending portions of the stress-strain curve, however, the effect is more pronounced in the descending part of the low strength concrete. The presence of fi-

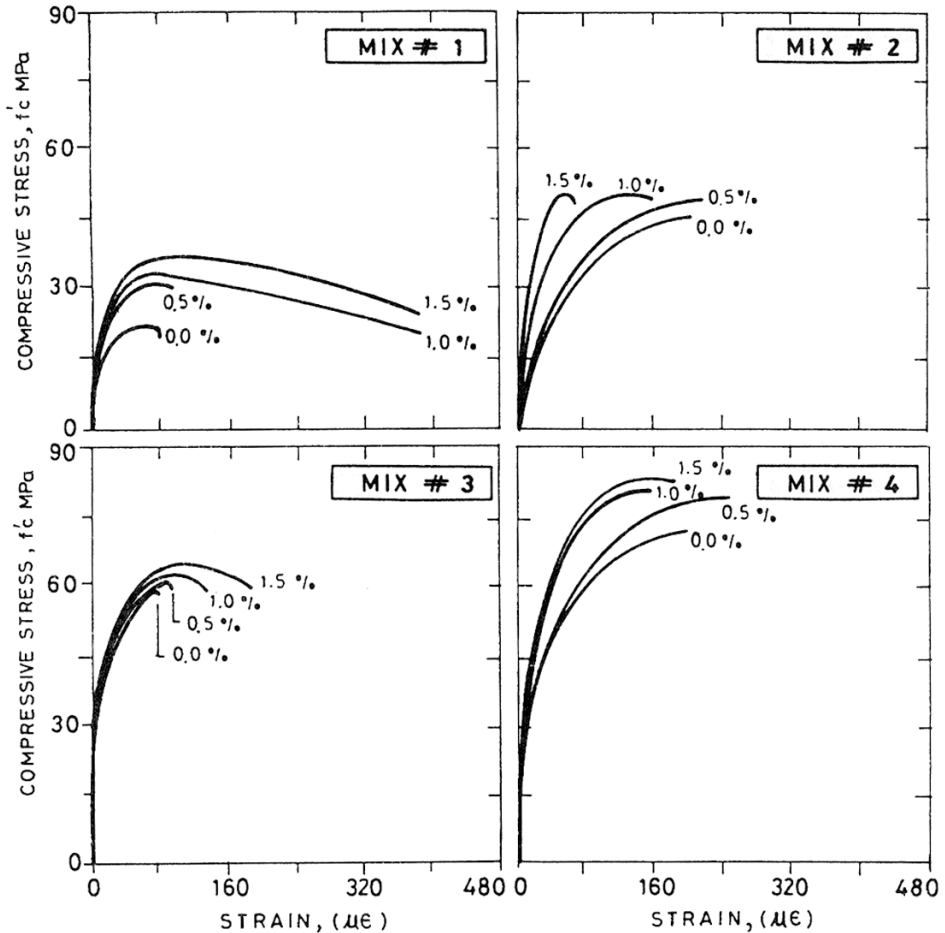

FIG. 2. Influence of the fiber content on the stress-strain curves.

ber altered the failure mode of the concrete cylinders from a brittle to a more ductile failure. Increasing  $V_f$  from 0.0 to 1.5% resulted in a slight increase in the strain at peak stress.

Table 1 and Fig. 3 show that increasing the steel fiber content from 0.0 to 1.5% in all mixes caused increase in the compressive strength ranged from 12 to 50% compared to an increase from 0 to 15% for normal-strength concrete [15-18] and 4.6% for high-strength concrete[19]. The contribution of fibers is more effective in the lower strength concrete.

Fig. 4a shows the relationship between the compressive strength values determined using  $150 \times 300$  mm [ $f'_{c(150)}$ ] and  $100 \times 200$  mm [ $f'_{c(100)}$ ] cylinders

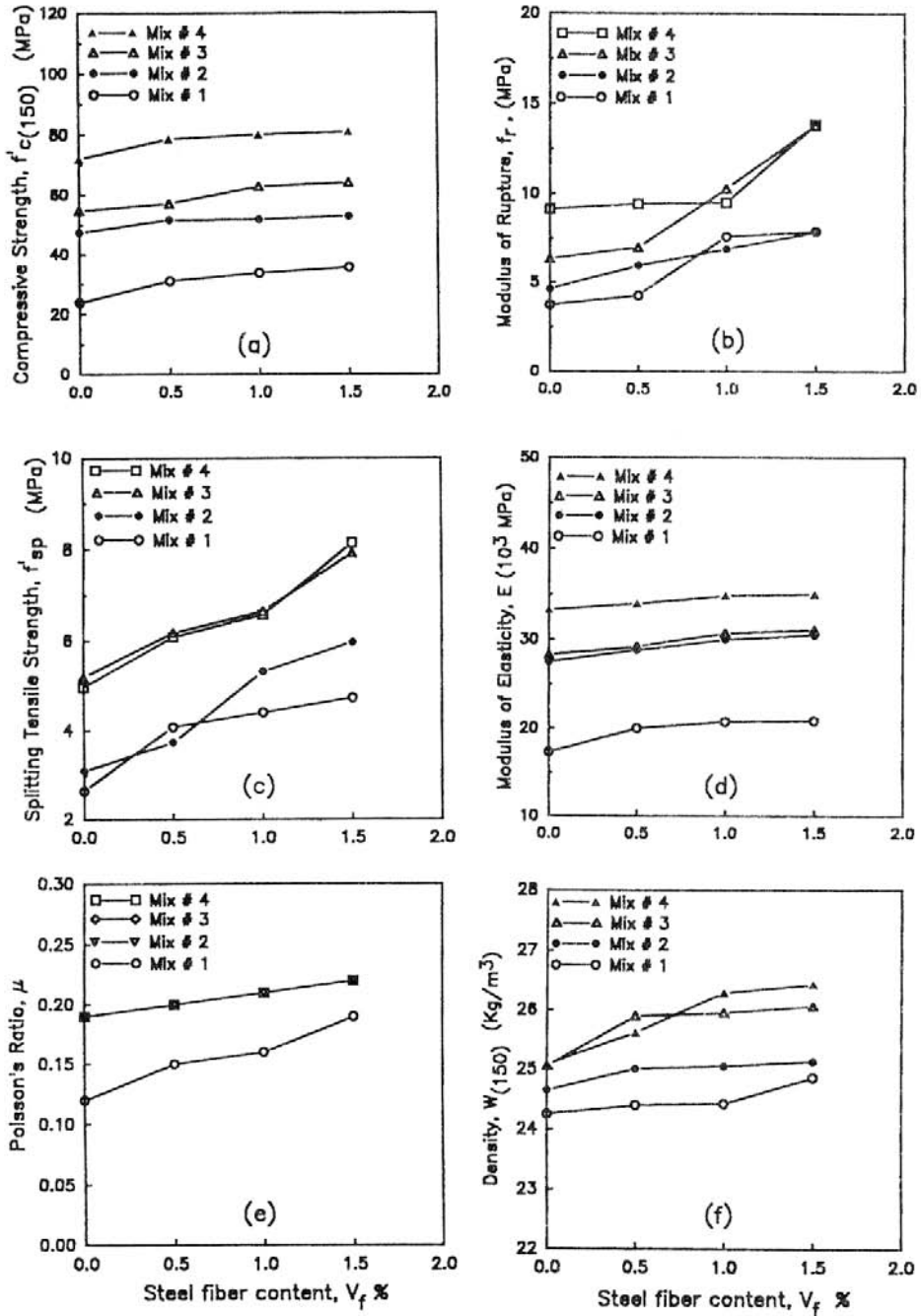

FIG. 3. Influence of the steel fiber content on various concrete properties.

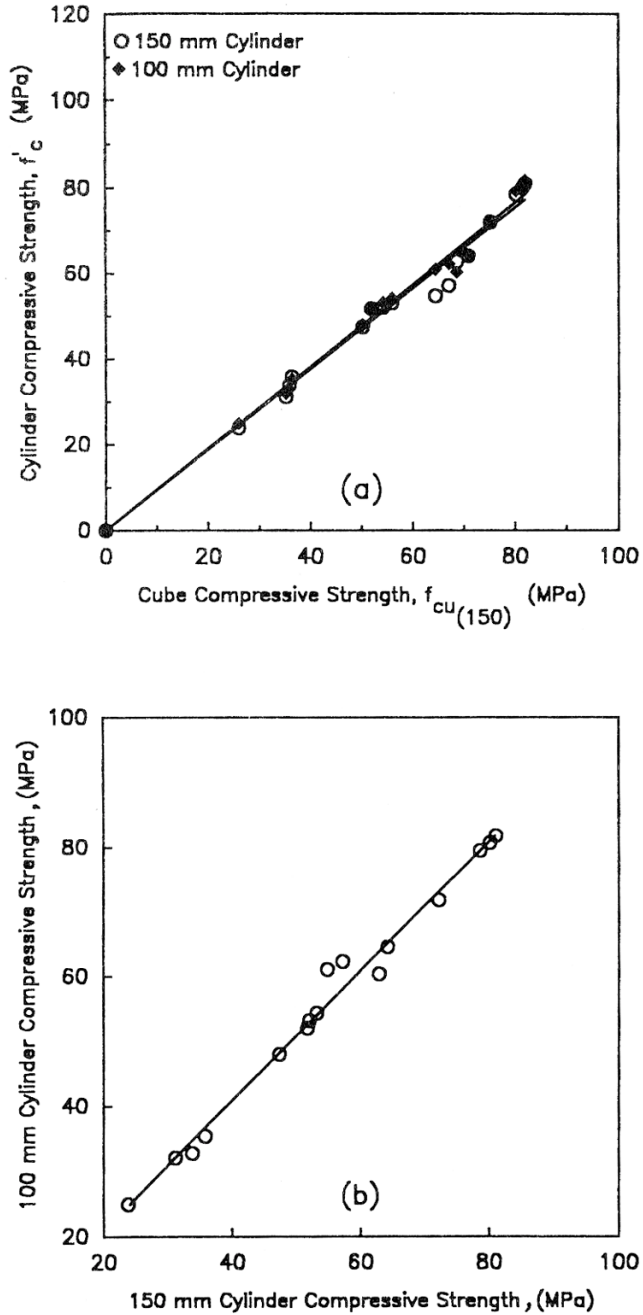

FIG. 4. Variation of compression strength values as a function of the specimens shape.

versus 150 mm [ $f'_{cu(150)}$ ] cubes. A regression analysis of the test results of 96 cylinders and 48 cubes provided the following relationship:

$$f'_{c(150)} = 0.94 f'_{cu(150)} \quad (1 - a)$$

$$f'_{c(100)} = 0.96 f'_{cu(150)} \quad (1 - b)$$

Fig. 4b shows the variation of the compressive strength of the 100 × 200 mm ( $f'_{cu(100)}$ ) cylinder when compared with 150 × 300 mm cylinder ( $f'_{cu(150)}$ ). The following expression is estimated:

$$f'_{c(100)} = 1.01 f'_{cu(150)} \quad (2)$$

This equation indicates that the compressive strength of 100 × 200 mm cylinder is slightly (1%) higher than the larger cylinder (150 × 300 mm) which agrees with ACI 363-R92<sup>[1]</sup>.

### 3.2. Modulus of Rupture

The flexural strength (modulus of rupture) tests (ASTM C 1018) were performed using 150 × 150 × 530 mm [ $f'_{r(150)}$ ] and 100 × 100 × 350 mm [ $f'_{r(100)}$ ] prisms loaded at third points. Results of beam specimens showed that beam without fiber had little ductility, and once the maximum tensile stress was reached the beam failed suddenly after the occurrence of the first crack without warning as presented in Fig. 5. The failure characteristics were, however, completely changed as a result of the addition of fibers. After the occurrence of initial cracking, the specimen did not fail and the randomly oriented fibers crossing the cracked section resisted the propagation of cracks and separation of the section. The fiber presence resulted in more closely-spaced cracks, reduces the crack width, and bridges crack. This caused an increase in the load-carrying capacity beyond the first cracking. The applied load ultimately reached a peak values. This value is a function of the fiber content, the fiber tensile strength and the fiber bond strength<sup>[8]</sup>. Beyond the peak value; the applied load decreased gradually up to failure. This may be attributed to the straightening of some of the fibers present at the cracked section and the possible loss of their bond with concrete resulting in a decrease of the peak tensile strength of the section. Table and Fig. 3b show that for the different concrete compressive strength, increasing the steel fiber content from 0.0 to 1.5% increases the modulus of rupture by about 69 to 118% for the 150 × 150 × 530 mm prisms, compared to about 50 to 70% for normal-strength concrete<sup>[15-18]</sup> and 67 to 81.7% for high strength concrete<sup>[19]</sup>.

Fig. 6 shows the variation of the modulus of rupture values of 150 × 150 × 530 mm, 100 × 100 × 350 mm prisms as a function of the concrete compressive strength. Based on regression analysis of the test result of 96 prisms, the following equations are obtained:



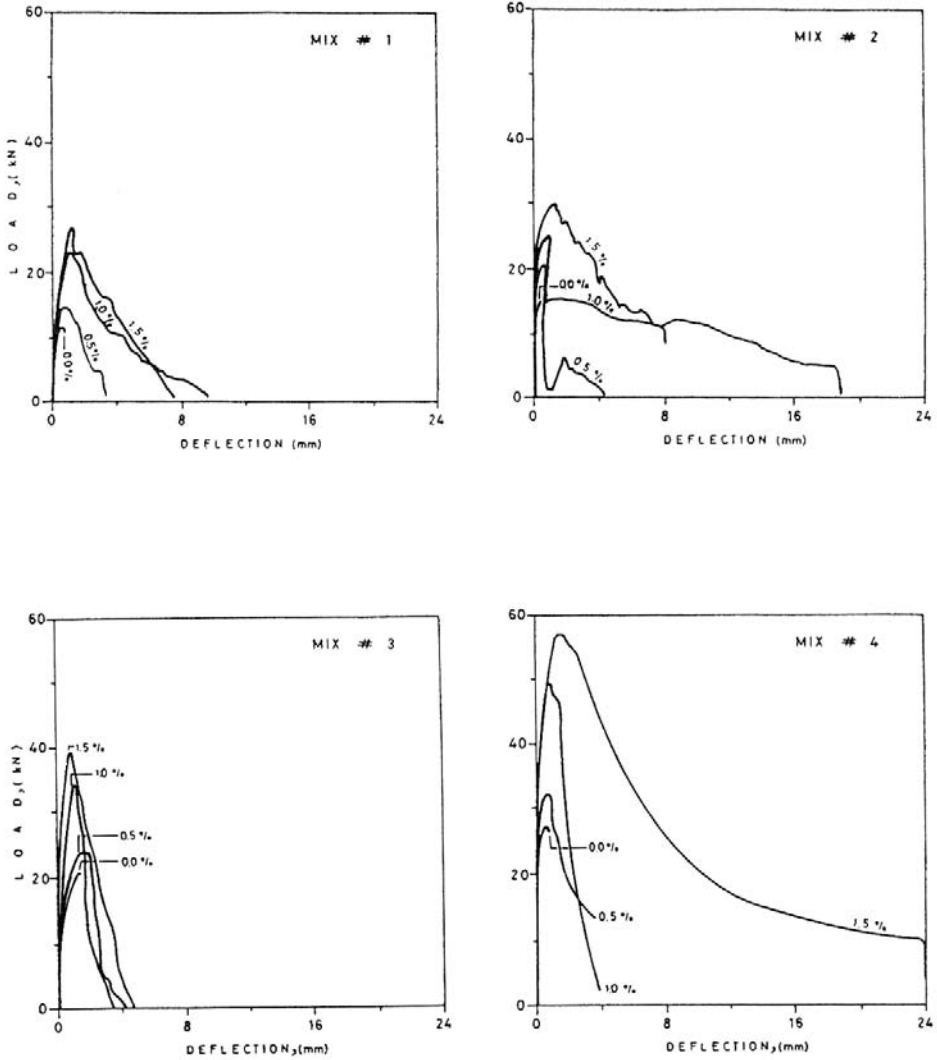

FIG. 5. Influence of the fiber content on load-deflection curves.

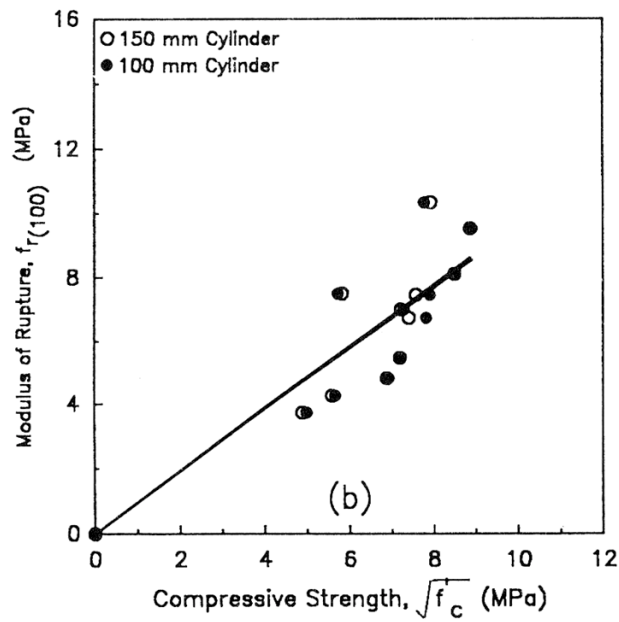
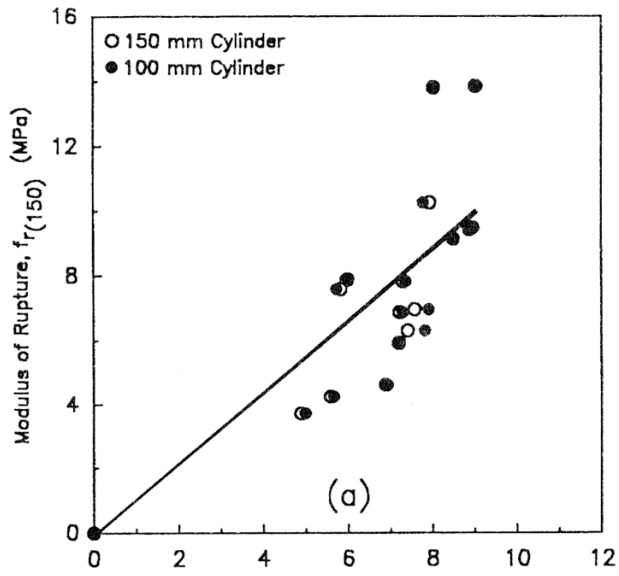

FIG. 6. Variation of the modulus of rupture with the concrete compressive strength.

$$f_{r(150)} = 1.12 \sqrt{f'_{c(150)}} \quad (3a)$$

$$f_{r(150)} = 1.11 \sqrt{f'_{c(100)}} \quad (3b)$$

$$f_{r(100)} = 0.97 \sqrt{f'_{c(150)}} \quad (3c)$$

$$f_{r(100)} = 0.96 \sqrt{f'_{c(100)}} \quad (3d)$$

Fig. 7 shows the correlation between the modulus of rupture values measured using the  $100 \times 100 \times 350$  mm and  $150 \times 150 \times 530$  mm prisms for various fiber contents. A regression analysis provided the following relationship:

$$f_{r(150)} = 0.97 f_{r(100)} \quad (4)$$

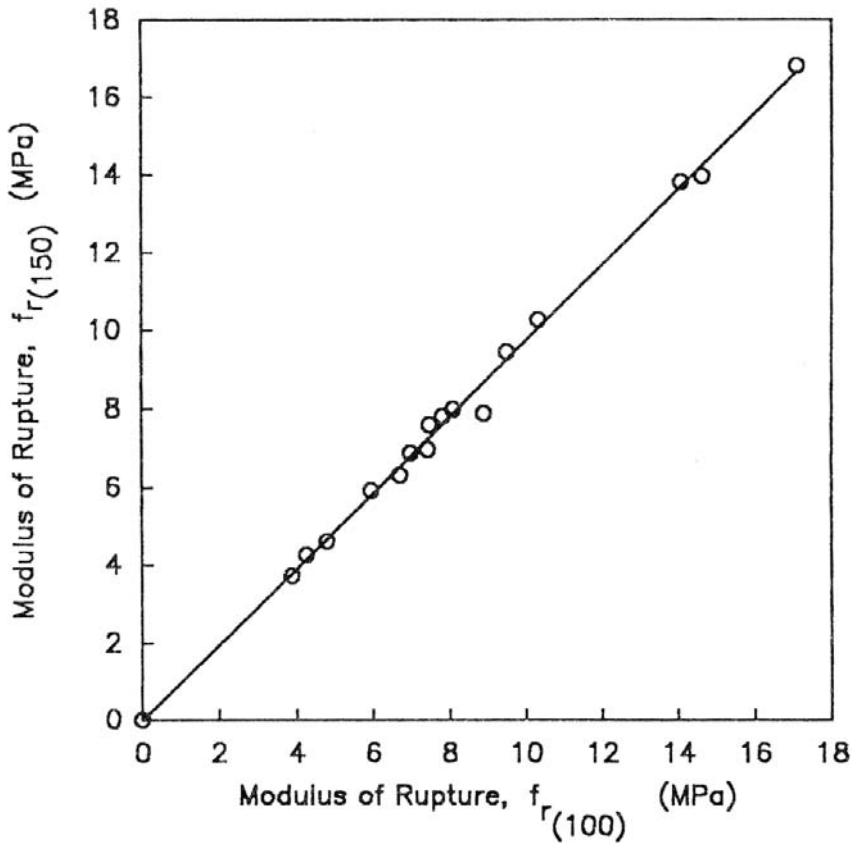

FIG. 7. Relationship between modulus of rupture of  $150 \times 150 \times 530$  and  $100 \times 100 \times 350$  mm prisms.

This equation yields higher values than those given by Johnson<sup>[15]</sup> of 0.94 for normal-strength FRC, and by Wafa *et al.*<sup>[13]</sup> of 0.91 for high-strength concrete.

Ductility or energy absorption of concrete is increased considerably by the addition of fibers. The ductility is calculated as the area under the load-deflection curve and is given in Table 1. All the specimens made of plain concrete failed immediately after the first cracks and hence the ductility for these specimens is ranged between 11 and 35 kN-mm. The ductility for specimens reinforced with fibers was between 30 and 430 kN-mm depending on the percentage of fiber content.

### 3.3. Splitting Tensile Strength

The indirect tensile strength (splitting tensile strength) tests (ASTM C 496) were carried out using 150 × 300 mm cylinders. Table 1 and Fig. 3c show that the peak value of the splitting tensile strength,  $f'_{sp}$ , depends on the fiber content and the compressive strength. Increasing the fiber content from 0.0 to 1.5% increases the splitting tensile strength by about 53 to 94%.

Fig. 8 shows the variation of the splitting tensile strength as a function of the concrete compressive strength. Based on the test result of 48 cylinders tested in split tension, a regression analysis was performed and the following equations are provided:

$$f'_{sp} = 0.69 \sqrt{f'_{c(150)}} \quad (5a)$$

$$f'_{sp} = 0.69 \sqrt{f'_{c(100)}} \quad (5b)$$

Fig. 9 shows the relationship between the modulus of rupture of 150 × 150 × 530 and 100 × 100 × 350 mm prisms and the splitting tensile strength of 150 × 300 mm cylinders. A regression analysis of the test results provided the following relationship:

$$f'_{sp} = 0.69 f_{r(150)} \quad (6a)$$

$$f'_{sp} = 0.68 f_{r(100)} \quad (6b)$$

### 3.4. Modulus of Elasticity

The modulus of elasticity of concrete varies with the compressive strength value and the fiber content. The experimental modulus of elasticity values using 150 × 300 mm cylinder were estimated using the secant modulus from 25 to 50% of the compressive strength. Fig. 3d shows that the increase of both the steel fiber content and the compressive strength increase the modulus of elasticity.

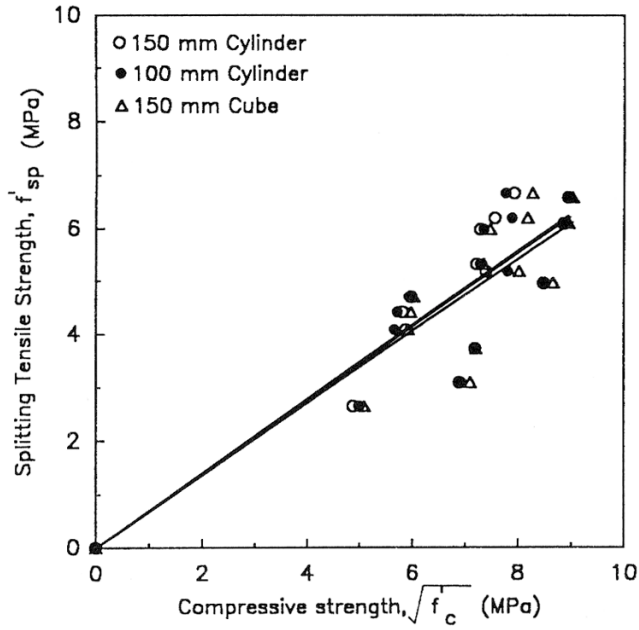

FIG. 8. Relationship between the splitting tensile strength and the compressive strength.

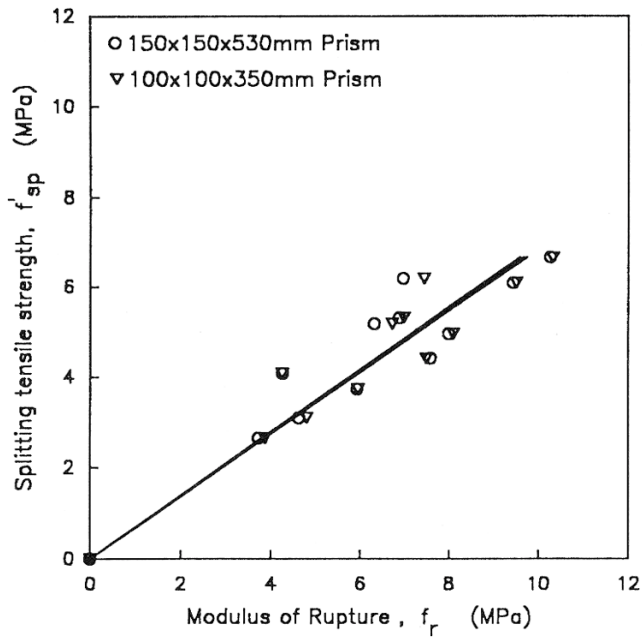

FIG. 9. Relationship between the splitting tensile strength of prisms and the modulus of rupture of cylinders.

### 3.5. Poisson's Ratio

Table 1 and Fig. 3e show that the increase of both the concrete compressive strength and the fiber content increase the Poisson's ratio values ( $\mu$ ). The values of  $\mu$  ranged from 0.12 to 0.19 for concrete with no fibers and from 0.19 to 0.22 for concrete with 1.5 % fibers. While  $\mu$  for normal weight concrete ranged between 0.15 to 0.20.

### 3.6. Density

Table 1 and Fig. 3f show the effect of the increase of the concrete compressive strength and the fiber content on the density of FRC used. The density of the plain concrete specimens ranged from 2425 to 2505  $\text{kg/m}^3$  and for concrete with 1.5% fibers ranged from 2486 to 2643  $\text{kg/m}^3$ .

Fig. 10 shows the relationship between the density and the concrete strength of 150 mm cylinder. A regression analysis gives the following equation:

$$W = 2.2 \times 10^3 + 52 \sqrt{f_{c(150)}} \quad (7)$$

and for normal plain concrete  $W = 2300 \text{ kg/m}^3$  and slightly higher value for high strength concrete than lower strength concrete.

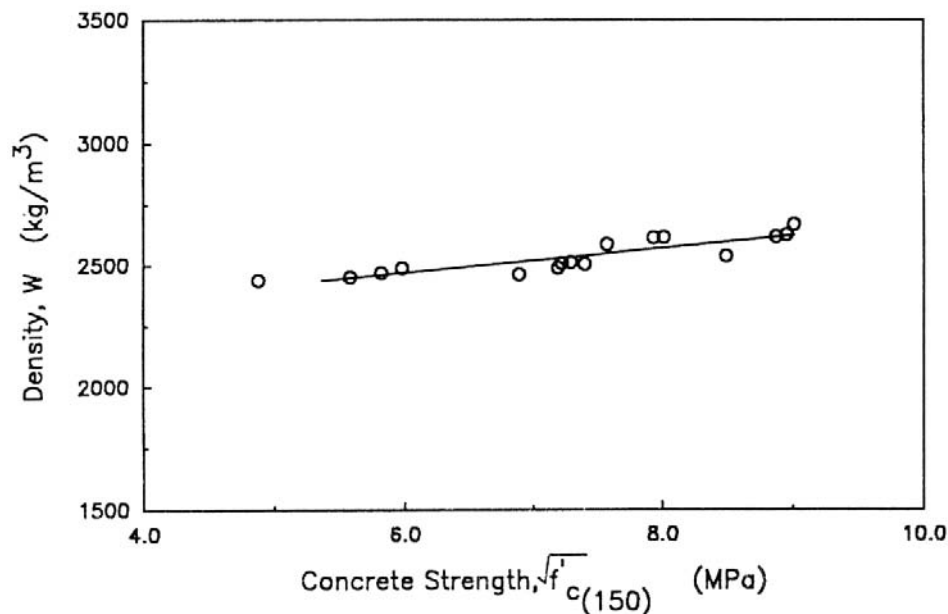

FIG. 10. Variation of the concrete density with compressive strength.

#### 4. Conclusion

Based on the test results of 288 normal and high-strength concrete specimens using hooked steel fiber reinforcement with an aspect ratios of 75, the following conclusions are drawn:

1. No real workability problem was encountered when up to 1.5% hooked-ends steel fibers were used in the mixtures. However, FRC mixtures required in general more mixing and finishing times than mixes without fibers.
2. High-strength concrete is a brittle material and fails suddenly. Addition of steel fibers in discrete forms into high-strength concrete changes its brittle mode of failure into a more ductile one.
3. Addition of fiber result in more closely-spaced cracks, reduces the crack width, bridges cracks and thus improves resistance to deformation.
4. The addition of 1.5% by volume of hooked-end steel fibers results in an increase of about 12 to 50%, in the compressive strength, an increase of 50 to 120% in the modulus of rupture, and an increase of 53 to 94% in the splitting tensile strength compared with the unreinforced matrix.
5. The ductility of plain concrete ranges between 11 and 35 kN-mm, while for fiber-reinforced concrete it was found to be in the rage of 30 and 43 kN-mm depending on steel fiber content.
6. The ratio of flexural strength (modulus of rupture) of  $150 \times 150 \times 530$  mm to  $100 \times 100 \times 350$  mm prisms was about 0.96 regardless of the steel fiber contents.

#### References

- [1] **ACI Committee 363**, "State of The Art Report on High-Strength Concrete, (ACI 363R-92)," American Concrete Institute, Detroit, 1992, 55 p.
- [2] **Nilson, A.H.**, "Design Implications of Current Research on High-Strength Concrete," High-Strength Concrete, ACI SP-87, American Concrete Institute, Detroit, 1987, pp. 85-109.
- [3] **Swamy, R.N.**, "High-Strength Concrete-Material Properties and Structural Behavior," High-Strength Concrete, ACI SP-87, American Concrete Institute, Detroit, 1987, pp. 110-146.
- [4] **Carrasguillo, R.L., Nilson, A.H. and Slate, F.O.**, "Properties of High-Strength Concrete Subject to Short-Term Loads," *ACI Journal, Proceedings*, Vol. **78**, No. 3, May-June 1981, pp. 171-178.
- [5] **Swamy, R.N.**, "Properties of High-Strength Concrete," *Cement, Concrete, and Aggregates*, Vol. **8**, No. 1, Summer 1986, pp. 33-41.
- [6] **Martinez, S., Nilson, A.H. and Slate, F.O.**, "Spirally Reinforced High-Strength Concrete Columns," *ACI Journal, Proceedings* Vol. **81**, No. 5, Sept. - Oct. 1984, pp.431-442.
- [7] **Slate, F.O., Nilson, A.H. and Martinez, S.**, "Mechanical Properties of High-Strength Lightweight Concrete," *ACI Journal, Proceedings* Vol. **83**, No. 4, July. - Aug. 1986, pp. 606-613.
- [8] **ACI Committee 544**, "State of The Art Report of Fiber Reinforced Concrete," *ACI Concrete International*, Vol. **4**, No. 5, May 1982, pp. 9-30.

- [9] **Rumualdi, J.P.** and **Batson, G.B.**, "The Mechanics of Crack Arrest in Concrete," *Journal of the Engineering Mechanics Division, ASCE*, Vol. **89**, No. EM-5, June 1983, pp. 147-168.
- [10] **Naaman, A.E.**, "Fiber Reinforcement For Concretes," *ACI Concrete International*, Vol. **7**, No. 3, March 1985, pp. 21-25.
- [11] **Naaman, A.E.** and **Homrich, J.R.**, "*Properties of High-Strength Fiber Reinforced Concrete*," *High-Strength Concrete, SP-87*, American Concrete Institute, Detroit, 1985, pp. 233-249.
- [12] **ACI Committee 363**, "Research Needs for High-Strength Concrete (ACI 363-IR-87)," *ACI Materials, Proceedings* Vol. **84**, No. 6, Nov. - Dec. 1987, pp. 559-561.
- [13] **Wafa, F.F.**, **Ashour, S.A.** and **Hasanain, G.S.**, "Flexural and Shear Behavior of High-Strength Fiber Reinforced Concrete Beams," Final Report, Research No. 069/410, College of Engineering, King Abdulaziz University, Jeddah, Saudi Arabia, July 1991, 107 p.
- [14] **ACI Committee 544**, "*Measurement of Properties of Fiber Reinforced Concrete (ACI 544, 2R-89)*," American Concrete Institute, Detroit, 1989, 11 p.
- [15] **Johnston, C.D.**, "*Steel Fiber Reinforced Mortar and Concrete - A Review of Mechanical Properties*," *Fiber Reinforced Concrete, SP-44*, American Concrete Institute, Detroit, 1974, pp. 127-142.
- [16] **Williamson, G.R.**, "*The Effect of Steel Fibers on The Compressive Strength of Concrete*," *Fiber Reinforced Concrete, SP-44*, American Concrete Institute, Detroit, 1974, pp. 195-207.
- [17] **Kar, N.J.** and **Pal, A.K.**, "Strength of Fiber Reinforced Concrete," *Journal of the Structural Division, ASCE*, Vol. **98**, No. ST-5, May 1972, pp. 1053-1068.
- [18] **Ramakrishnan, V.**, **Oberling, G.** and **Tatnall, P.**, "Flexural Fatigue Strength of Steel Fiber Reinforced Concrete," *Fiber Reinforced Concrete Properties and Applications, SP-105*, American Concrete Institute, Detroit, 1987, pp. 225-245.
- [19] **Wafa, F.F.** and **Ashour, S.A.**, "Mechanical Properties of High-Strength Concrete Beams", *ACI Materials Journal, Proceeding* Vol. **89**, No. 5, Sept. - Oct. 1992, pp. 449-455.
- [20] **ACI Committee 318**, "*Building Code Requirements for Reinforced Concrete (ACI 318-95)*," American Concrete Institute, Detroit, 1995, 369 p.
- [21] **Bakhsh, A.H.**, **Wafa, F.F.** and **Akhtaruzzaman, A.A.**, "Torsional Behavior of Plain High-Strength Concrete Beams," *ACI Structural Journal, Proceedings* Vol. **87**, No. 5, Sept. - Oct. 1990, pp. 583-588.
- [22] **Johnston, C.D.**, "Steel Fiber Reinforced and Plain Concrete: Factors Influencing Flexural Strength Measurement," *ACI Journal, Proceedings* Vol. **79**, No. 2, March-April 1982, pp. 131-138.



**Notation**

$f'_c$	=	Cylinder compressive strength of concrete, MPa,
$f'_{cu}$	=	Cube compressive strength of concrete, MPa,
$f'_{sp}$	=	Splitting tensile strength of plain concrete, MPa,
$f_r$	=	Modulus of rupture of plain concrete, MPa,
HSC	=	High-strength concrete,
$V_f$	=	Steel fibers volume content, %
$\mu$	=	Poisson's ratio,
FRC	=	Fiber reinforced concrete,
E	=	Modulus of elasticity of concrete, GPa,
W	=	Density, kg/m <sup>3</sup> .

## الخواص الميكانيكية للخرسانة العادية وعالية المقاومة المسلحة بالألياف الحديدية

تميم عبد الهادي سمان ، فيصل فؤاد وفا و طلال عبد الملك رادين  
 قسم الهندسة المدنية ، كلية الهندسة ، جامعة الملك عبد العزيز  
 جدة - المملكة العربية السعودية

المستخلص . الخرسانة عالية المقاومة سريعة الانكسار (هشة) ، وتقلل الزيادة في قوة الخرسانة من لدانتها . وتمثل العلاقة العكسية بين قوة الخرسانة ولدانتها عائقاً رئيساً في استعمالات الخرسانة عالية المقاومة ، ويمكن تحسين العلاقة بين هاتين الخاصتين بإضافة ألياف متقطعة إلى الخرسانة مما يؤدي إلى جعلها أكثر تجانساً وموحدة الخواص ويحول أداءها الهش إلى مادة أكثر ليونة .

الغرض من هذه الدراسة إجراء تجارب معملية لدراسة الخواص الميكانيكية لخرسانة عادية وعالية المقاومة المسلحة بألياف حديدية . تم اختبار ٢٨٨ عينة بقوة ضغط للخرسانة تتراوح بين ٢٤ و ٨١ ميجاباسكال لتقييم تأثير الألياف الحديدية على أداء الإجهاد والانفعال ، وقوة ضغط الخرسانة ، ومعامل الانقطاع ، ومقاومة شد الانشطار ومعامل المرونة ونسبة بوسان لكل من الخرسانة العادية وعالية المقاومة .